

No-Frost, Side-by-Side Refrigerator- Freezer

Use and Care Guide

ROPER

Appliances

RS22AMXV
RS25AWXV

Thank you for choosing a Roper appliance. This guide will help you operate and maintain your new, quality-built Roper refrigerator-freezer. Keep this guide in a safe place for future reference.

Complete and mail the Product Registration Card.

This card enters your warranty into our warranty system that insures efficient

claim processing, can be used as a proof of purchase for insurance claims and helps Roper to contact you immediately in the unlikely event of a product-safety recall.

Please remember ...

It is your responsibility to be sure that your refrigerator:

- Has been properly installed and leveled according to the Installation Instructions given on Page 3.
- Is installed on a floor that can support

the weight of the refrigerator.

- Is properly connected to a grounded electrical circuit that meets the electrical requirements. (See Page 3.)
- Is properly used only for the job it was designed to do.
- Is not used by children or anyone unable to operate it properly.
- Is cold in both the refrigerator and freezer sections before food is added.
- Is properly maintained.

Energy-saving tips.

- Check the door gaskets for a tight seal. Level the refrigerator to be sure of a good seal.
- Clean dust and lint from the condenser coils every other month.
- Open the doors as seldom as possible. Decide what you need before you open the door. Remove everything you need at one time. Organize and

label food so you will not have to search for items you want. Close door immediately after you remove food items.

- Store food in the refrigerator and freezer so that air movement is not blocked.
- Set the refrigerator and freezer temperatures so that the drinks remain cold enough for your family's taste and ice cream remains

firm. Do Not set temperatures colder than they need to be.

- Set the Power-Saving Control on "CONSUMES LESS ENERGY" unless moisture forms on the outside of the refrigerator.
- Do Not install your refrigerator next to your range, water heater, furnace, radiator, other heat sources or in direct sunlight.

Contents

Page No.

Product registration.....	1
Energy-saving tips.....	1
Food storage suggestions.....	2
Important Safety Instructions.....	2
Before using your refrigerator-freezer...	
Removing labels.....	3
Cleaning the refrigerator.....	3
Plugging in the refrigerator.....	3
Installing the refrigerator.....	3
Leveling the refrigerator.....	3
Using your refrigerator-freezer.	
Setting the controls.....	4
Changing control settings.....	4
Power-Saver Control.....	4
Adjusting meat drawer temperature.....	4
Adjusting the refrigerator shelves.....	5
Removing and adjusting freezer shelves.....	5
Removing crisper, meat drawer and covers.....	5
Removing the base grille.....	5
Using and maintaining special model features.	
RS22AM.....	6
Changing the light bulbs.....	6
Removing freezer basket.....	6
Automatic ice maker.....	6
RS25AW.....	7-8
Changing the light bulbs.....	7
Removing freezer basket.....	7
Cold water and ice dispenser.....	7-8
Before you call for service for your cold water and ice dispenser.....	8
Cleaning your refrigerator-freezer.....	9
If electricity goes off.....	10
Vacation and moving guide.....	10
Before you call for service...	
Operating problems chart.....	11
Normal operating sounds.....	11
If you need assistance, service or replacement parts.....	12
Warranty.....	12

Food storage suggestions.

For information about fresh and frozen food storage techniques see a cookbook or check with your local county extension agent or public utility home economist.

Store fresh or frozen foods in packages or containers that provide a good seal against air and moisture.

Important Safety Instructions

! WARNING

Reduce risk of fire, electrical shock, or personal injury when using your refrigerator-freezer, by following basic precautions, including the following:

- Read all operating instructions before using your refrigerator-freezer.
- Do Not store or use gasoline or other flammable vapors and liquids in the vicinity of this or any other appliance. The fumes can create a fire or explosion.
- Use only a properly grounded electrical outlet. Check with a qualified electrician if you are in doubt as to whether the refrigerator is properly grounded. Do Not modify the plug on the power cord. If it will not fit the outlet, have a proper outlet installed by a qualified electrician.
- Do Not use an extension cord.

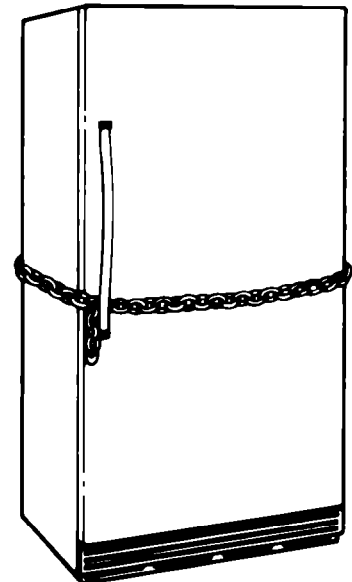
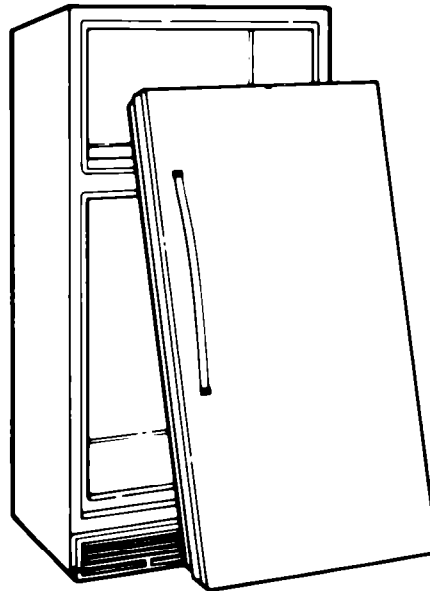

- Do Not allow children or anyone unable to safely operate the refrigerator-freezer to operate, play with or crawl inside the refrigerator-freezer.
- Never discard or store your old refrigerator-freezer (even for just a few days) without safely removing or sealing the refrigerator-freezer doors. Prevent entrapment and suffocation accidents by reading the enclosed safety booklet from the Association of Home Appliance Manufacturers.

Important note: Your freezer cannot quick-freeze large quantities of food. Put in only as much unfrozen food as will freeze within 24 hours. (No more than 2 to 3 pounds of food per cubic foot of freezer space.) Leave enough space for air to circulate around packages. Check to make sure that you leave enough room at the front of the freezer to tightly close the door.

Save these Instructions.

Before using your refrigerator-freezer...

A. Remove the energy and sales information labels...

by lifting one edge of each label and pulling straight off. Use a damp cloth to take off any glue residue. Remove all shipping tape.

- Do Not use any sharp instruments or any harsh, abrasive cleansers.
- Do Not use rubbing alcohol or flammable toxic solvents such as acetone, gasoline, carbon tetrachloride, etc.
- Do Not remove any permanent instruction labels inside the refrigerator.
- Do Not remove the Tech Sheet.

B. Clean the refrigerator ...

inside and out before plugging it into an outlet. Cleaning instructions are given on Page 9.

CAUTION

Do Not use an outlet that can be turned off with a switch or pull chain.

C. Plug the refrigerator ...

into a 115-volt, 60-Hz., AC only, 15- or 20-ampere, fused and properly grounded electrical supply. Use a separate circuit serving only the refrigerator. See electrical requirements and grounding instruction sheet in literature package for complete details.

D. Install the refrigerator ...

according to the dimensions shown. Leave extra space along the hinge-side walls to allow the doors to be opened wider. Make sure ice maker water supply line has been connected.

Do Not install the refrigerator:

- next to an oven, radiator or other heat source;
- out in the weather or direct sunlight;
- in an area where the room temperature will fall below 55°F (13°C).

Leave 1/2" (1.25 cm) at the top and each side of the refrigerator for easier installation.

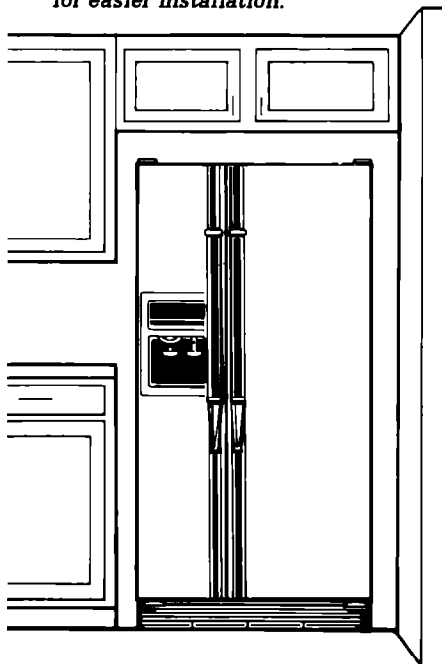

Refrigerator can be installed flush against back wall.

E. Level the refrigerator.

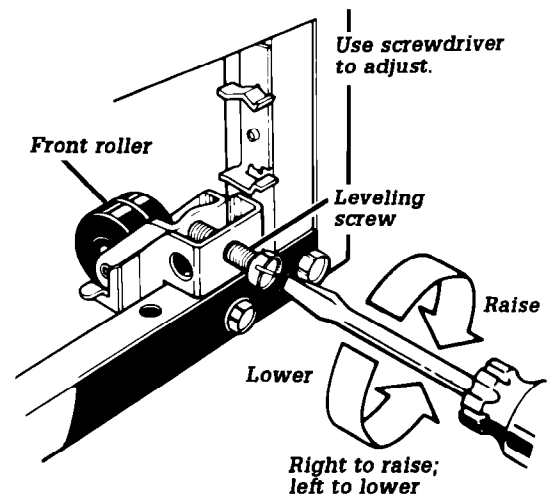

Make sure the refrigerator is level for efficient operation.

1. Remove base grille (see Page 5).
2. Place a level on top of the refrigerator — first side to side then front to back. Turn each leveling screw to the right to raise the front of the refrigerator. Turn each leveling screw to the left to lower the front of the refrigerator.
3. Check the levelness again and repeat Step 2 until the refrigerator is level.
4. Replace base grille.

Using your refrigerator-freezer.

Setting the controls.

Controls for the refrigerator and freezer are in the refrigerator.

When you plug in the refrigerator ...

1. Set the Refrigerator Control to 3.
2. Set the Freezer Control to B.
3. Let the refrigerator and freezer

4. compartments get cold for several hours before adding food.
4. When the refrigerator keeps milk or juice as cold as you like and the freezer keeps ice cream firm, the settings are correct for your household.

Changing control settings.

1. Adjust the Refrigerator Control according to the settings listed below.
2. Wait 24 hours or more before making additional adjustments to the Refrigerator Control or adjusting the Freezer Control.

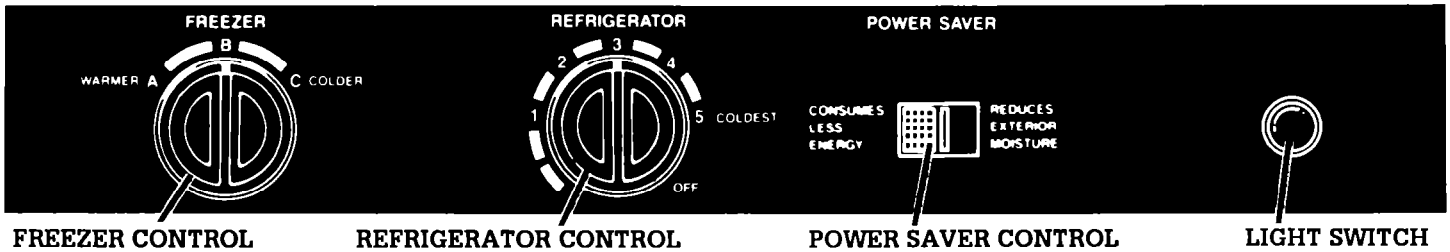

Condition	Check if	Set control setting
Refrigerator section TOO WARM.	Door is opened often. Large amount of food added. Too-warm room temperature.	Refrigerator 4 Freezer A
Freezer section TOO WARM.	Door is opened often. Large amount of food added. Too-cold room temperature (freezer can't cycle often enough).	Refrigerator 3 Freezer C
Both sections TOO WARM.	Door is opened often. Large amount of food added. Too-warm or too-cold room temperatures.	Refrigerator 4 Freezer B
Refrigerator section TOO COLD.	Controls not set correctly.	Refrigerator 2 Freezer B
Ice is not made fast enough.	Heavy ice usage. Very cold room temperature (can't cycle often enough).	Refrigerator 3 Freezer C

Power-Saver Control.

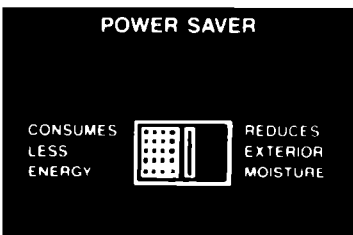

The Power-Saver Control operates electric heaters around the door openings. These heaters help keep moisture from forming on the outside of the refrigerator.

1. Set at "Consumes Less Energy" when humidity is low.
2. Set at "Reduces Exterior Moisture" when moisture appears on the outside of the refrigerator. (A red dot appears when the switch is in this position.)

Adjusting meat drawer temperature.

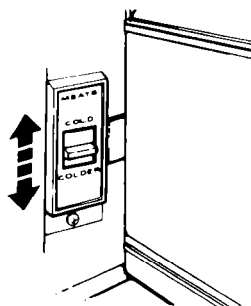

The meat drawer temperature control lets more or less cold air flow from an opening between the freezer and the refrigerator. This helps to keep the meat drawer colder than the rest of the refrigerator. Set the control to the coldness level you want.

Using your refrigerator-freezer, continued.

Adjusting the refrigerator shelves.

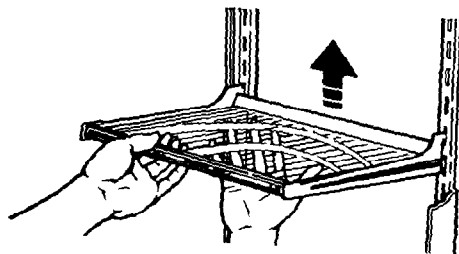

NOTE: Glass shelves are strong enough to hold bottles, milk cartons and other heavy food items.

To remove glass shelf:

1. Remove food from shelf.
2. Tilt up front.
3. Lift up back until hooks clear the shelf support slots.
4. Pull shelf straight out. Be careful — glass shelves are heavy!

To replace glass shelf:

1. Insert the rear hooks into the shelf support slots.
2. Tilt up front until hooks drop into slot. Lower front of shelf to level position.

Removing and adjusting the freezer shelves.

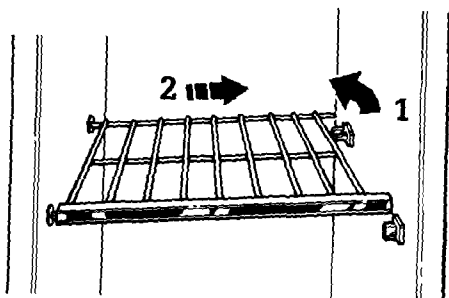

To remove the shelf:

1. Remove food from shelf.
2. Lift right side of shelf off wall supports.
3. Slide shelf out of supports.
4. Replace in reverse order.

To adjust the shelf:

1. Remove food from shelf; then remove shelf.
2. Slide supports upward and remove.
3. Slide supports downward into new position.
4. Replace shelf.

Note: The cup-shaped supports go in the back of the freezer.

Removing crisper, meat drawer and covers.

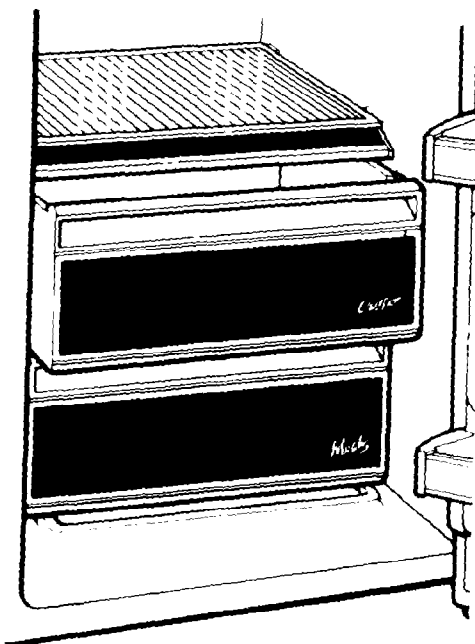

To remove crisper and meat drawer:

1. Slide crisper or meat drawer straight forward to the guide stops.
2. Lift the front until it clears stops.
3. Slide crisper or meat drawer the rest of the way out.
4. Replace in reverse order.

To remove the covers:

1. Push up glass insert from the bottom, then slide out with both hands. (Be careful — the glass is heavy!)
2. Lift front of cover frame and pull up and out.
3. Repeat for meat drawer cover.

To replace covers:

1. Fit meat drawer cover notches into supports on walls of refrigerator. Lower cover into place.
2. Repeat for crisper cover frame.
3. Slide back of crisper cover glass insert into place; then lower front.

Removing the base grille.

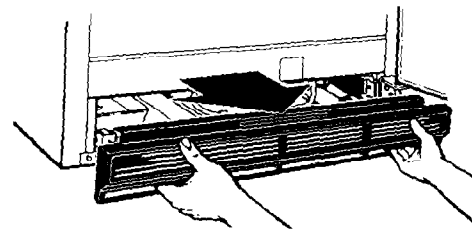

To remove:

1. Open the refrigerator and freezer doors.
2. Pull grille outwards as shown.
3. Do Not remove Tech Sheet fastened behind grille.

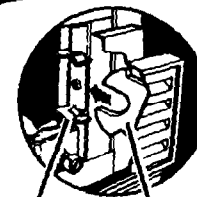
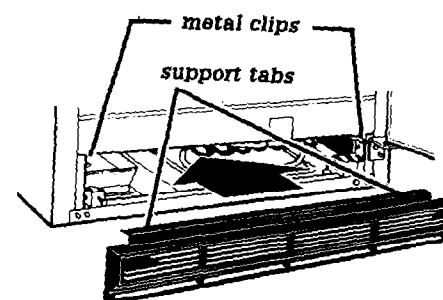

metal clips

support tabs

To replace:

1. Line up grille support tabs with metal clips
2. Push firmly to snap into position.
3. Close the doors.

Using and maintaining special model features.

Model RS22AM

Changing the light bulbs.

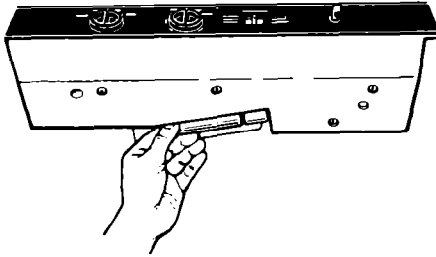

⚠ WARNING

Electrical Shock Hazard
Unplug the refrigerator or disconnect the main electric power supply to the refrigerator. Failure to do so can result in electrical shock or injury.

To change refrigerator light bulb:

1. Remove the light bulb from the socket located behind the control console.
2. Replace with a 40-watt, tubular appliance bulb.

To change light bulb above crisper or freezer light bulb:

1. Grasp front of light shield.
2. Pull bottom of shield forward until it snaps free.
3. Remove bulb from socket.
4. Replace with a 40-watt, tubular appliance bulb.
5. Place shield over bulb and snap back into place.

Removing freezer trivet.

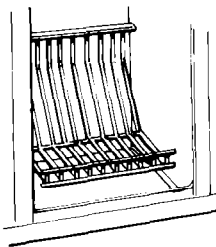

For proper air movement, keep freezer trivet in place when the refrigerator is operating.

To remove the trivet:

1. Lift trivet up.
2. Pull trivet forward.

To replace the trivet:

1. Slide trivet into refrigerator.
2. Lower trivet into place.

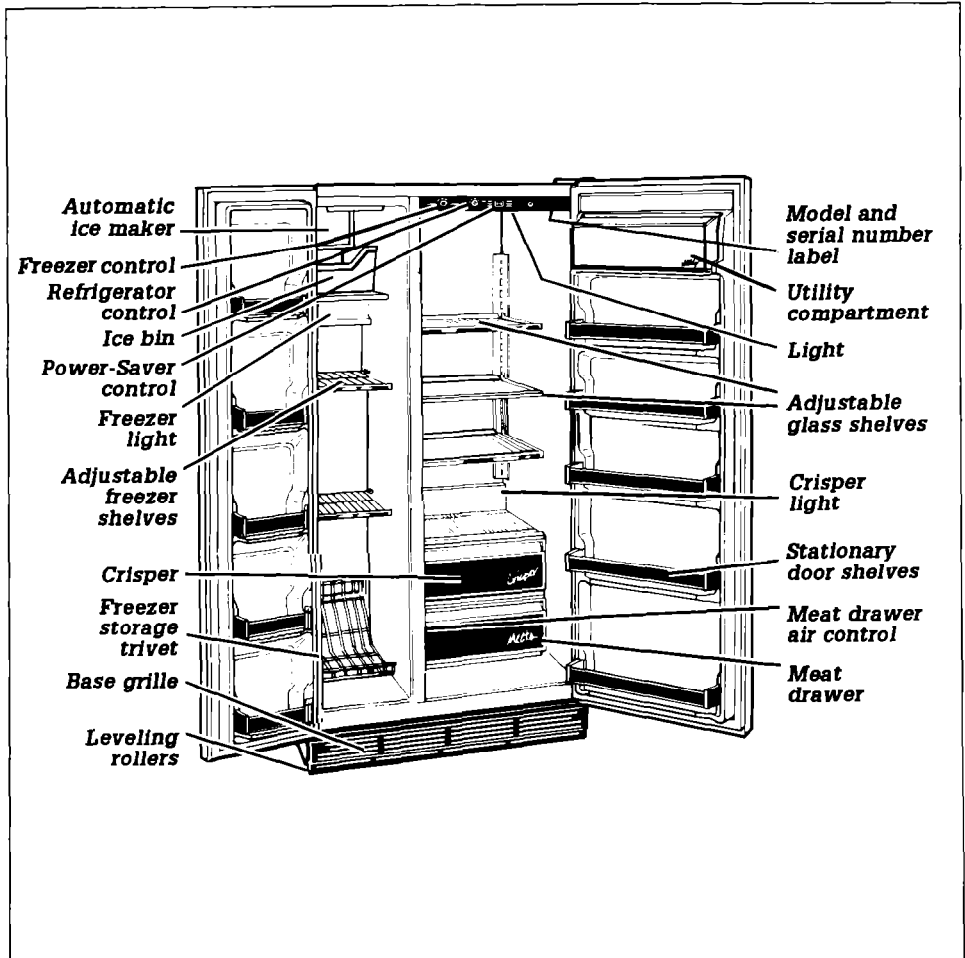

Automatic ice maker. (Models RS22AM and RS25AW).

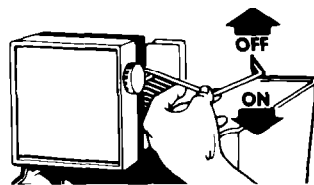

1. Connect the ice maker to the water supply before turning it on.
2. The ON/OFF lever is a wire signal arm.
 - Lower signal arm to make ice.
 - Raise signal arm to turn off the ice maker.

Automatic ice maker tips.

- Freezer must be cold enough for the ice maker to work. This may take eight hours or more before the right temperature is reached.
- "First" ice may be discolored or off-flavored because of new plumbing connections. Throw away first few batches of ice.
- Change ice cube size with the dial or lever on the side of the ice maker.
- Ice crescents are normally attached at the corner. They break apart easily.

- Normal sounds include water running when the ice maker is working and the thud of ice as it falls into the bin.
- If ice is not being made fast enough and more ice is needed, turn the Refrigerator Control to a higher number. Wait 24 hours, and if this does not increase the ice supply, turn the Freezer Control to C.
- Raise the signal arm before you remove the ice bin. When you return the bin, push it all the way in and lower the arm to the ON position.
- Cubes left in the bin for long periods of time may develop an off-flavor, like stale water. Throw old cubes away. Cubes may also become smaller if stored for a long time.
- Good water quality is important for good ice quality. It is not recommended that you connect the ice maker to a softened water supply. If a softened water supply cannot be avoided, it is important to maintain the water softener so it operates properly. Water softener chemicals, such as salt from a malfunctioning softener, can damage the ice maker mold and lead to poor quality ice.

Using and maintaining special model features.

Model RS25AW

Changing the light bulbs.

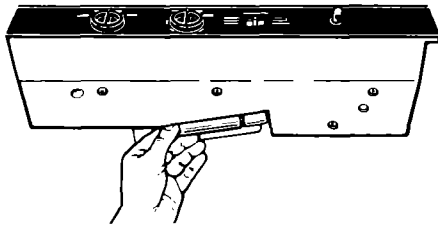

WARNING

Electrical Shock Hazard
Unplug the refrigerator or disconnect the main electric power supply to the refrigerator. Failure to do so can result in electrical shock or injury.

To change refrigerator light bulb:

1. Remove the bulb from the socket located behind the control console.
2. Replace with a 40-watt, tubular appliance bulb.

To change light bulb above crisper:

1. Grasp front of light shield.
2. Lift front of shelf up and pull shield out.
3. Remove bulb from socket.
4. Replace with a 40-watt, tubular appliance bulb.
5. Place shield over bulb and push into place.

To change upper freezer light bulb:

1. Lift top of shield up and pull shield out.
2. Remove bulb from socket.
3. Replace with a 40-watt, tubular appliance bulb.
4. Place shield over bulb and snap into place.

To change lower freezer light bulb:

1. Push in sides of light shield until it snaps free.
2. Remove bulb from socket.
3. Replace bulb with a 40-watt, appliance bulb.
4. Place shield over bulb and snap into place.

Removing the freezer basket.

To remove the basket:

1. Slide the basket forward to the guide stops.
2. Lift front of basket until it clears stops. Slide basket the rest of the way out.

To replace the basket:

1. Place basket on the slides.
2. Lift slightly until the stops clear the front of guides.
3. Slide basket in.

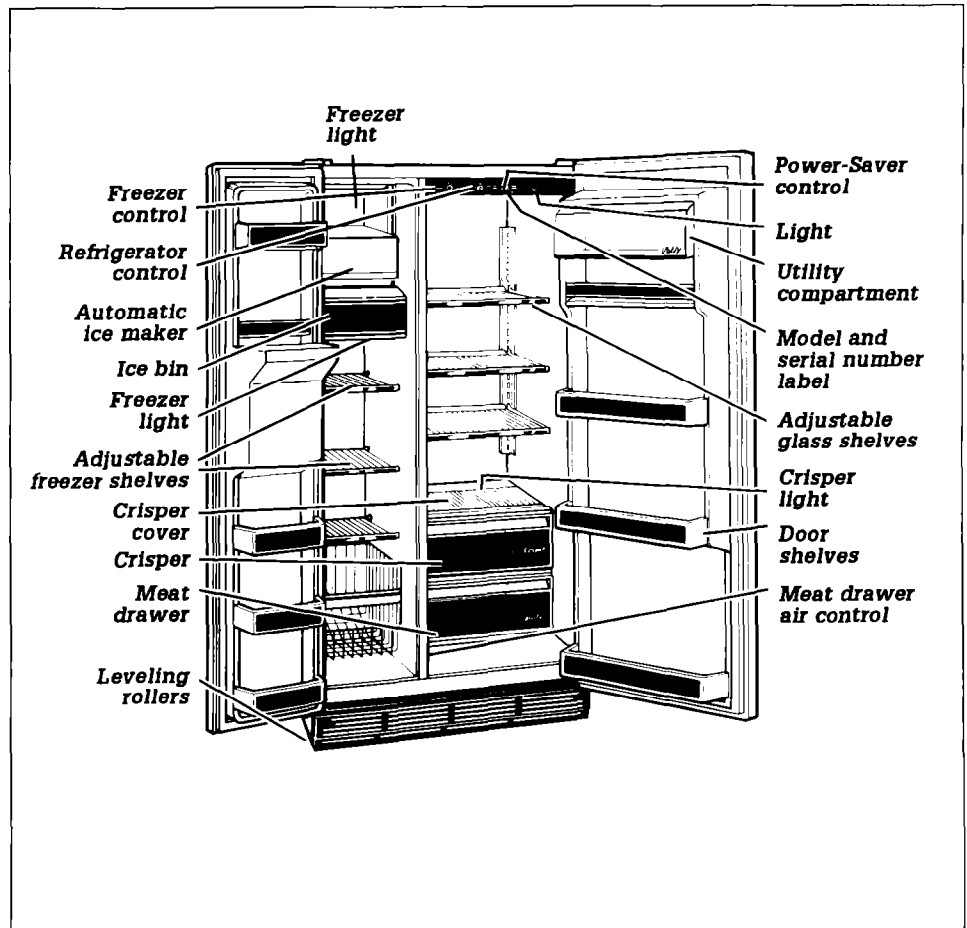

Cold water and ice dispenser.

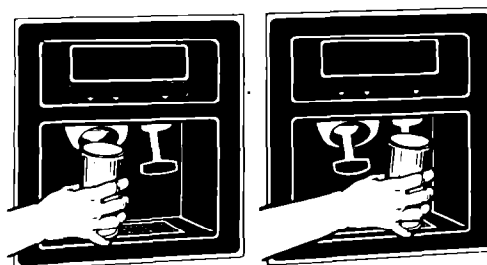

The small tray beneath the dispenser is designed to evaporate small spills. Do Not pour water into it. There is no drain in this tray.

A. How the ice dispenser works.

Ice comes from the ice maker storage bin in the freezer. When the dispenser bar is pressed, ice falls through a chute between the ice bin and dispenser and out an open trap door. When the dispenser bar is released, a faint buzzing sound may be heard for a few seconds.

B. How to dispense ice.

1. Press a sturdy glass against the ice dispenser bar. (Pressure and tumbling ice can break a fragile glass.)
2. To stop the ice from dispensing, remove the glass.

Note: "First" ice may be discolored or off-flavored because of new plumbing connections. Throw away first few batches of ice.

C. How the cold water dispenser works.

Chilled water comes from a 50-ounce (1.5 l) tank (approximate) behind the meat drawer. When the refrigerator is first hooked up, rinse the tank and pipes by pressing the water dispenser with a sturdy glass or jar. Discard 2 to 3 quarts (1.9 to 2.8 l). Then allow the first tankful of water to chill for several hours.

D. How to dispense cold water.

1. Press a sturdy glass against the water dispenser bar. (Pressure can break a fragile glass.)
2. To stop the water from dispensing, remove glass.

Using and maintaining special model features.

Model RS25AW Continued

E. Removing and emptying the ice storage bin.

Remove the ice maker storage bin if:

- ice dispenser has not or will not be used for a week.
- a power failure causes ice to melt and freeze together.
- ice dispenser is not used regularly.

1. Lift covering panel up from the bottom and slide it back to the rear.
2. Lift the ice maker signal arm until it clicks into the OFF position. Ice can be dispensed, but no more will be made.
3. Lift the front of the storage bin and pull the bin out.
4. Empty the bin. Use hot or warm water to melt any remaining ice. **Do Not use sharp objects to break up ice in the bin. This can damage the bin and dispenser mechanism.**

5. Wash the bin with mild detergent. Rinse well.

Do Not use harsh or abrasive cleansers or solvents.

6. Slide the bin back into place. Make sure it is pushed in all the way.
7. Lower the signal arm to the ON position to restart ice production.

F. Automatic Ice maker.

For use and care information, see Page 6.

G. Changing ice dispenser light bulb.

1. Remove the bulb from the socket inside the dispenser area.
2. Replace bulb with a heavy-duty, 10-watt bulb.

Cold water and ice dispenser tips.

- Use only ice crescents from the ice maker. Other shapes will not dispense properly.

- Large amounts of ice (more than two glasses) should be taken from the ice maker storage bin not the dispenser. The dispenser motor may stop if the dispenser bar is held in too long. If the motor stops, it will restart in about 3 minutes.
- Cubes left in the bin for long periods of time may develop an off-flavor, like stale water. Throw old cubes away. Cubes may also become smaller if stored for a long time.
- Good water quality is important for good ice quality. It is not recommended that you connect the ice maker to a softened water supply. If a softened water supply cannot be avoided, it is important to maintain the water softener so it operates properly. Water softener chemicals, such as salt from a malfunctioning softener, can damage the ice maker mold and lead to poor quality ice.

Before you call for service for your cold water and ice dispenser...

If you are having an operating problem, check this chart to see what might be the cause before you call for assistance.

Operating problem	Check if	What to do
Cold water and ice dispenser will not work.	Freezer door is open.	Close the freezer door.
Ice dispenser will not work.	Ice storage bin is pushed in all the way.	Push bin in all the way.
	Non-crescent-shaped ice is in bin. Old ice has clumped together.	Use only ice crescents from ice maker. Other shapes won't dispense properly. Throw away old ice and make new.
Ice dispenser stops working.	Ice dispenser bar is held in too long.	Wait about 3 minutes for dispenser motor to reset. Large amounts of ice should be taken from the bin, not through the dispenser.
Off-taste or odor in ice.	Airborne odors are near ice. Ice is old. Water quality is good.	Use ice immediately or store in covered container. Throw away old ice and make new. Water containing minerals (such as sulfur) may require a filter.
	Foods are properly wrapped.	Store frozen foods in packages or containers that provide a good seal against moisture and air.
	Ice bin and freezer are clean.	Clean ice storage bin and freezer. Directions are on Pages 8 & 9.
	Ice maker is properly plumbed.	Properly hook up ice maker water supply. See Installation Instructions.
	New ice maker.	Note: First ice may be discolored or off-flavored because of new plumbing connections. Throw away first few batches of ice and make new ice.

Cleaning your refrigerator-freezer.

Both the refrigerator and freezer sections defrost automatically. To help prevent odors, wipe up spills immediately. Clean both sections once a month.

A. Turn Refrigerator Control to OFF and unplug it.

B. Take out all removable parts and clean according to the following directions:

! WARNING

Reduce risk of fire, electrical shock, personal injury or damage when using your refrigerator-freezer by following basic precautions including the following:

- Unplug power supply cord or disconnect power supply at the fuse or circuit breaker box before cleaning your refrigerator-freezer.
- Do Not clean shelves, crisper bins, the interior, etc. with flammable

fluids. This can create a fire or explosion.

- Do Not use any sharp instruments to clean your refrigerator-freezer.
- Do Not use window sprays, abrasive scouring cleansers, rubbing alcohol or flammable toxic solvents such as acetone, gasoline, carbon tetrachloride, etc. to clean your refrigerator-freezer. This can scratch or damage surfaces or parts.

Part	What to use	How to clean
Removable parts (shelves, crispers, meat pans, etc.)	Sponge or cloth; mild detergent and warm water.	Wash with wet sponge or cloth. Rinse and dry.
Outside	Sponge, cloth or paper towel; mild detergent and warm water; appliance wax (or good auto paste wax).	Wash with wet sponge, cloth or paper towel. Rinse and dry. Twice a year — apply appliance wax or good auto paste wax to painted metal surfaces with a clean, soft cloth. Waxing painted, metal surfaces provides rust protection. Do Not use wax on plastic parts.
Inside walls (Allow the freezer walls to warm up so cloth won't stick.)	Sponge, soft cloth or paper towel; mild detergent and warm water OR two tablespoons (26 g) baking soda to one quart (.95L) warm water.	Wash with wet sponge, cloth or paper towel. Rinse and dry.
Door liners and gaskets	Sponge, soft cloth or paper towel; mild detergent and warm water.	Wash with wet sponge, cloth or paper towel. Rinse and dry.
Dark plastics (covers and panels)	Soft, clean sponge or soft cloth; mild detergent and warm water.	Wash with wet sponge or soft cloth. Rinse and dry.
Defrost pan	Sponge or soft cloth; mild detergent and warm water.	Remove base grille. (See Page 5). Lift defrost pan over wire brace (remove any tape). Wash defrost pan with wet sponge or cloth and mild detergent. Rinse and dry. Replace defrost pan with notched corner to the rear. Push pan all the way in. Check that defrost pan tubing is pointing into pan. Replace base grille.
Condenser coil	Vacuum cleaner with extended, narrow attachment.	Remove base grille (see Page 5). Vacuum dust and lint from condenser coils at least every other month. Replace base grille.
Floor under refrigerator	Floor cleaner.	Roll refrigerator out away from wall. Clean the floor. Roll refrigerator back into place. Check levelness of refrigerator.

If electricity goes off...

A. Call the power company.
Ask how long power will be off.

B. Keep both doors closed if service will be interrupted 24 hours or less.

This will help frozen food stay frozen.

C. If service is disrupted for more than 24 hours ...

Remove all frozen food and store in a frozen food locker

OR

Place 2 lbs. (0.9 kg) of dry ice in freezer

for every cubic foot of freezer space. This will keep food frozen for 2 to 4 days.

WARNING

Personal Injury Hazard
Wear gloves to protect your hands from dry ice burns. Failure to do so could result in dry ice burns.

OR

If dry ice or a food locker is not available, use perishable food at once or preserve by other methods.

NOTE: A full freezer stays colder longer than a partly filled one.

A freezer full of meat stays colder longer than a freezer full of baked goods.

If food contains ice crystals, it may be safely refrozen, but the quality and flavor of the food may be affected.

Use refrozen food quickly. If the condition of the food is poor, or you feel it is unsafe to eat, dispose of it immediately.

Vacation and moving guide.

Before you leave

What to do

Automatic Ice Maker

For less than four weeks

Use up perishable foods. Freeze other food items.

Lift signal arm to turn off the ice maker. Shut off water supply to the ice maker. Empty ice bin.

For more than four weeks

Remove all food.
Turn Refrigerator Control to OFF.
Unplug refrigerator.
Clean, rinse and dry the interior.
Keep refrigerator and freezer doors slightly open by taping wood or rubber blocks at the top of each door. This allows air to enter the refrigerator and freezer and prevents odors and mold from building up inside while you're away.

At least one day before you leave —
Shut off water supply to the ice maker.
When last load of ice drops, lift signal arm to turn off ice maker.
Empty ice bin.

WARNING

Personal Injury Hazard
Do Not allow children near the refrigerator when the doors are blocked open. Children may become injured or trapped.

To restart refrigerator when you return, see Page 4 for resetting controls.

Moving

Remove all food.
Pack frozen foods in dry ice.
Turn Refrigerator Control to OFF.
Unplug refrigerator.
Clean, rinse and dry the interior.
Take out all removable parts.
Wrap removable parts in paper and tape them all together. Store inside refrigerator.
Raise leveling legs.
Tape the doors shut.
Tape the electric cord to the cabinet exterior.
When you reach your new home, replace the removable parts and follow steps beginning on Page 3.
Remember to reconnect the water supply line.

At least one day before you move —
Shut off water supply to the ice maker. Disconnect the water line.
When last supply of ice drops, lift signal arm to turn off ice maker.
Empty ice bin.

Before you call for service...

If you are having an operating problem, check this chart to see what might be the cause before you call for assistance.

Operating problem	Check that	What to do
Refrigerator will not run.	Power cord is plugged into a live circuit with proper voltage. Refrigerator Control is turned on. Fuse has blown or circuit breaker has tripped. Also check if a time-delay fuse has been used.	Firmly plug power cord into electrical outlet. Check circuit voltage at fuse/circuit breaker box. Switch Refrigerator Control to ON. Replace fuse with a time-delay fuse of the correct capacity. Reset circuit breaker.
Rattling, jingling noise or unfamiliar sounds.	Nothing is on top or behind the refrigerator when the refrigerator is operating. These are "normal operating" sounds: humming from fans, clicking from thermostat or defrost cycle, or defrost water draining into the defrost pan.	Remove objects from the top or from behind the refrigerator. Read the "Normal operating sounds" section below.
Ice maker will not make ice.	Freezer compartment has had enough time to get cold. With a new refrigerator it may require cooling overnight to reach proper temperature. Signal arm is in the down position to start the ice maker. Water valve is turned to open position and water is reaching the ice maker.	Allow freezer to get cold enough. Put signal arm in the down position. Turn water valve to open position.
Water in the defrost pan.	Weather is hot and muggy.	Hot and muggy weather can cause water to collect in the drain pan. Since water levels may reach half-full in the pan, be sure to level the refrigerator so the pan does not overflow.
Light does not work.	Fuse has blown or circuit breaker has tripped. Power cord is plugged into a live circuit with proper voltage. Bulb is burned out.	Replace fuse with a time-delay fuse of the correct capacity. Reset circuit breaker. Firmly plug power cord into electrical outlet. Check circuit voltage at fuse/circuit breaker box. Replace bulb with an appliance bulb. Follow instructions on Pages 6 & 7.
Motor runs too long.	Condenser is free of lint and dust. Weather or room is hot or muggy. Door has been opened frequently or a large amount of food has been added to the refrigerator or freezer compartments.	Remove dust and lint from the condenser coils with a vacuum cleaner. If the temperature outside or inside is warm, motor-running noises are normal. Decide which food items you need before opening the refrigerator or freezer section. Motor noise is also normal when large amounts of food are added to the refrigerator-freezer compartments. Remember — your new refrigerator may be larger than your old refrigerator. It may have more space to cool, which requires a longer-running motor.

Normal operating sounds.

You can expect to hear the following sounds when your refrigerator-freezer is operating.

- Slight hum or soft hiss as the refrigerator's fan motor moves air.
- Clicking or snapping sounds occur when the refrigerator starts and stops running. The defrost timer also clicks when the defrost cycle starts and stops.
- Water sounds occur as water gurgles through tubing for a few minutes after refrigerator stops running. You may also hear defrost water running into the defrost-water pan.
- Buzzing sounds (from the ice maker water valve), trickling water and clatter (or thud) of ice may be heard.
- Operating sounds from the high-efficiency compressor and motor may last longer than your older refrigerator.

If you need assistance, service or replacement parts...

Read the warranty. Contact your local dealer to recommend a local service company or to obtain replacement parts.

You will need the model number and serial number when you call for assistance or service. Both numbers are located on a label attached on the inside, right wall of the refrigerator cabinet near the top of the unit.

LIMITED WARRANTY

ROPER

Appliances

This Roper appliance is warranted by Whirlpool Corporation to be free from defect in material and workmanship to the original domestic purchaser. Any parts which we find to be defective will be repaired or replaced at our option subject to the following limitations:

1. Repair or replace during the first thirty (30) days from the date of purchase any finishes (porcelain, enamel or other) and glass parts which we find to be defective.
2. Repair or replace during the first (1st) year from date of purchase any other part except for the finish, which we find to be defective.
3. Repair or replace during the first five (5) years from date of purchase any magnetron (on those units so equipped) which we find to be defective. Labor on any magnetron under warranty is limited to the first (1st) year from date of purchase.
4. During the second (2nd) through the fifth (5th) years from the date of original purchase on any product so equipped, any part of the refrigerating system (compressor, evaporator, condenser, drier or connecting tubing) or any part of the washer gear case assembly found defective in material or workmanship, will be supplied. Labor on the refrigerating system and gear case assembly under this warranty is limited to the first (1st) year from the date of original purchase.
5. Replacement parts furnished under the terms of this warranty are warranted only for the unexpired portion of the original warranty period and transportation charges relative to obtaining parts involved are the responsibility of the original consumer purchaser.
6. This warranty applies only to products properly installed, adjusted and operated in accordance with instructions found in the product literature. This warranty does not apply to any product which has been subjected to alteration, misuse, improper installation or delivery damage. Nor does it apply to costs for any service requested for demonstration or to confirm proper operation of appliance, or when used in other than, single-family household use.
7. Any repairs made under the terms of this warranty must be performed by a Roper brand appliance servicer authorized by warrantor.

SHOULD YOU HAVE ANY QUESTIONS CONCERNING THIS WARRANTY, PLEASE CONTACT:

Customer Relations Dept.
ROPER Brand Appliances
2000 M 63 North
Benton Harbor, MI 49022

Call Toll Free 1-(800) 44-ROPER
1-(800) 447-6737
Between 8:00 a.m. - 4:30 p.m.
Monday thru Friday, Eastern Time

If you write or call, please furnish complete model and serial number of appliance and date of purchase.

Under no circumstances shall Whirlpool Corporation be liable under this warranty for any loss of any incidental or consequential damages and all IMPLIED WARRANTIES ARE LIMITED TO THE SAME TIME PERIODS STATED HEREIN ON EXPRESS WARRANTIES FOR ROPER BRAND APPLIANCES.

Some states do not allow the exclusion or limitation of consequential damages or limitations of how long an implied warranty may last, so the above limitations or exclusions may not apply to you. This warranty gives you specific legal rights, and you may have other rights which may vary from state to state.

THIS IS A LIMITED WARRANTY WITHIN THE MEANING OF THAT TERM AS DEFINED IN THE MAGNUSON-MOSS ACT OF 1975.

If you need service for your Roper brand appliance:

- Contact your selling dealer for the authorized servicer in your area.
- OR-
- Phone 1(800) 44-ROPER [1-(800)447-6737] BETWEEN 8:00-4:30 Eastern Time - Monday thru Friday.

ROPER

Appliances